

# **CONTOIL®**

## **DN 15 - 50**

**Measurement**

# CONTOIL®

## Fuel oil meters DN 15 - 50

A versatile flow meter for oil, heavy oil and many other oil-like liquids. It is used for efficient consumption measurement of heat burners and various combustion engines. A reliable solution for any application where oil is consumed.



### Features:

- » State-of-the-art design
- » Electronic counter, mass flow, volume flow indication, multiple output signals
- » Integrated temperature sensor
- » No straight inlets or outlets required
- » Independent of viscosity and temperature
- » High vibration resistance
- » Optional: metrological type approval
- » Automatic medium switch based on temperature

### Benefits:

- » Mass flow measurements
- » Highly flexible mounting with very small space requirements
- » Reliable monitoring and flexible control of the system
- » Accurate measurements
- » A reliable solution with everything from a single supplier
- » Simplifies consumption optimizing

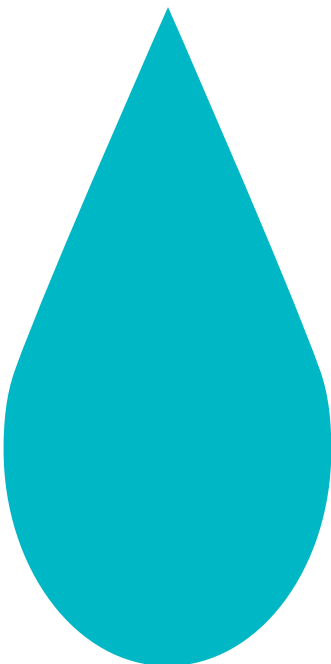

# CONTENT

Introduction	4
Operating principle	5
Product range	6
CONTOIL® flexibility	8
Technical specifications	11
Project planning notes	26
Installation	32
Warranty, safety instructions	37
Certificates	38

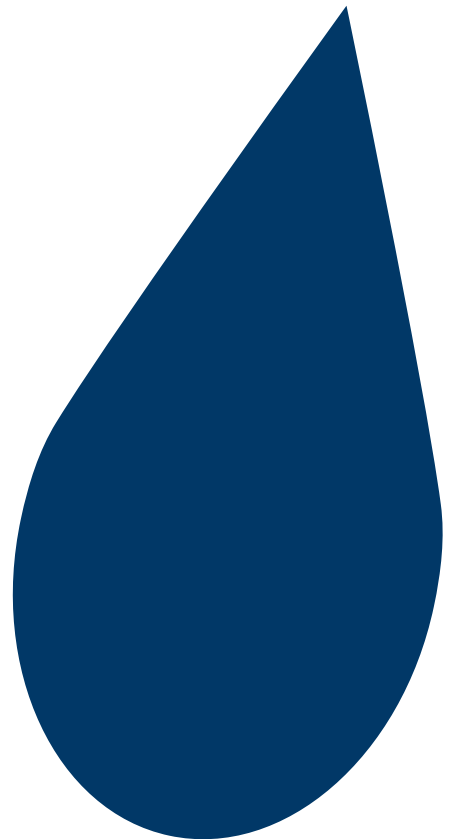
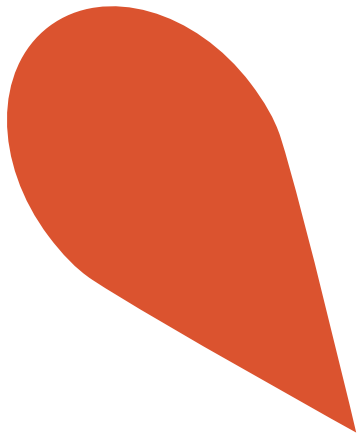

# INTRODUCTION

Thank you for your decision to work with Aquametro Oil & Marine Fuel Measurement Products. This technical specification describes the installation, commissioning and use of CONTOIL® fuel oil meters. For additional information please contact your local sales agent at: [www.aquametro-oil-marine.com](http://www.aquametro-oil-marine.com).

## Liability Disclaimer

The manufacturer cannot monitor the compliance to this manual as well as the conditions and methods during the installation, operation, usage and maintenance of the flow meter. Improper installation can cause damage and endanger people. Therefore, we assume no responsibility and liability for losses, damage or costs that result due to incorrect installation, improper operation, usage and maintenance or in any manner associated therewith. Similarly, we assume no responsibility for patent right or other right infringements of third parties caused by usage of this flow meter. The manufacturer reserves the right, without prior notification, to make modifications concerning the product, technical data or installation and operating manual.

## Safety precautions

CONTOIL® fuel oil meters must only be used for their intended purpose and comply with local and international safety regulations. All documentation is to be followed exactly. None of the information stated here or elsewhere releases planners, installers and operators from their own careful and comprehensive assessment of the respective plant configuration in terms of functional capability and operational safety.

- » Local applicable working regulations must be complied with, during all work on the plant and / or ship.
- » All safety, installation and operation instructions as described in this manual must be followed.
- » The flow meters are sensitive measuring instruments and should be treated carefully.



# OPERATING PRINCIPLE

## Function

CONTOIL® fuel oil meters work on the volumetric principle of rotary piston meters (positive displacement meters). The main features of this measuring principle are large measuring ranges, high accuracy, suitability for high viscosities and independence from power supply.

Flow disturbances do not influence proper operation.



Leading manufacturers of oil burners and operators of heating systems, ships or diesel engines rely on CONTOIL® fuel oil meters - and with good reasons.

### Advantages:

- » Optimal solution for every application
- » Mass flow measurement
- » Integrated temperature sensor
- » Simple burner setting with flow rate display
- » Simple flow monitoring with limiting value switch  $Q_{min} / Q_{max}$
- » Manual dosing feature, with a resettable counter
- » Can be mounted on the pressure or suction side of a pump
- » Space saving installation, because no straight inlet / outlet sections are required
- » Flexible mounting of the meter in horizontal, vertical or inclined positions
- » Accurate measurement result, since the reading is independent of the temperature and viscosity of the fluid
- » Minimum failure costs due to simple function monitoring, rapid fault analysis and the possibility of simple repairs on site

### Areas of application:

- » To measure fuel consumption of oil burners (e. g. in heating boilers, industrial furnaces, refinery plants)
- » Consumption monitoring and optimization (ships, generators, etc.)
- » Flow measurement for mineral oils
- » Optional remote processing and integration into superior systems
- » Manual dosing / filling / batch processing

### Fuel types:

- » Fluids according to ISO 8217-2010
- » Heating fuel extra light / light, medium, heavy, fuel blends
- » Naphtha
- » Lubricating liquids (oils)

# PRODUCT RANGE

## CONTOIL® fuel oil meters DN 15 - 50

### Hydraulic

#### CONTOIL® one hydraulic with multiple combination possibilities (display options)

Housing with threaded (RC) or flanged (FL) connection



#### Main characteristics:

- » Optimal flow range 20 - 30 000 l/h
- » Temperature ranges 130 and 180 °C
- » Nominal pressure PN 16, 25 and 40 bar

For more information, see page 12

### Electronic display

#### CONTOIL® VZF/A II with multifunctional display and adjustable outputs

#### Output signals for electronic display:

- » Volume and mass pulses
- » Actual flow rate and mass flow
- » Temperature display
- » Limiting values ( $Q_{min}$ ,  $Q_{max}$ )
- » Status switch (alarm, error)
- » External power supply (4 - 20 mA 2 wire current loop)
- » Simple to operate



For more information, see page 14

### Mechanical display module

#### CONTOIL® VZO/A total volume display

Total volume display on roller counter



For more information, see page 16

**Mechanical display with pulse  
CONTOIL® VZO/A RV/IN total volume  
display and remote transmission**

Total volume display on roller counter with  
 » Reed pulse (RV) for remote totalization  
 » Inductive pulse (IN) for control purposes



**For more information, see page 16**

**Blind unit with pulse output  
CONTOIL® DFM compact design for  
remote display transmission**

Pulse value for remote totalizing



**For more information, see page 18**

**CONTOIL® CE MID 2014/32/EU for  
verified applications where an approved  
measurement system is required**

Conformity approved read out

**For more information, see page 20**



# CONTOIL® FLEXIBILITY

Combination possibilities of hydraulic and display units

## Local electrical display with multiple output

Display unit with coupling and temperature sensor

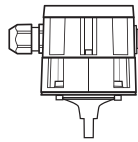

Hydraulics

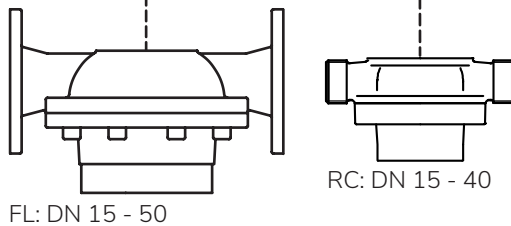

## Local mechanical display with or without pulse output

Display units

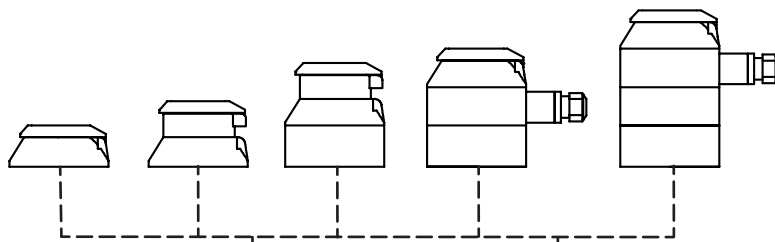

Hydraulics

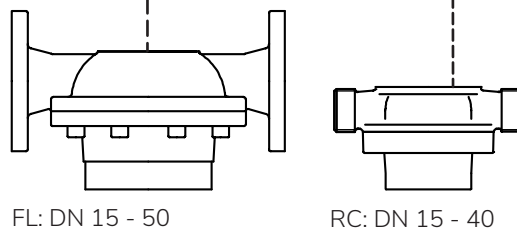



## Type key

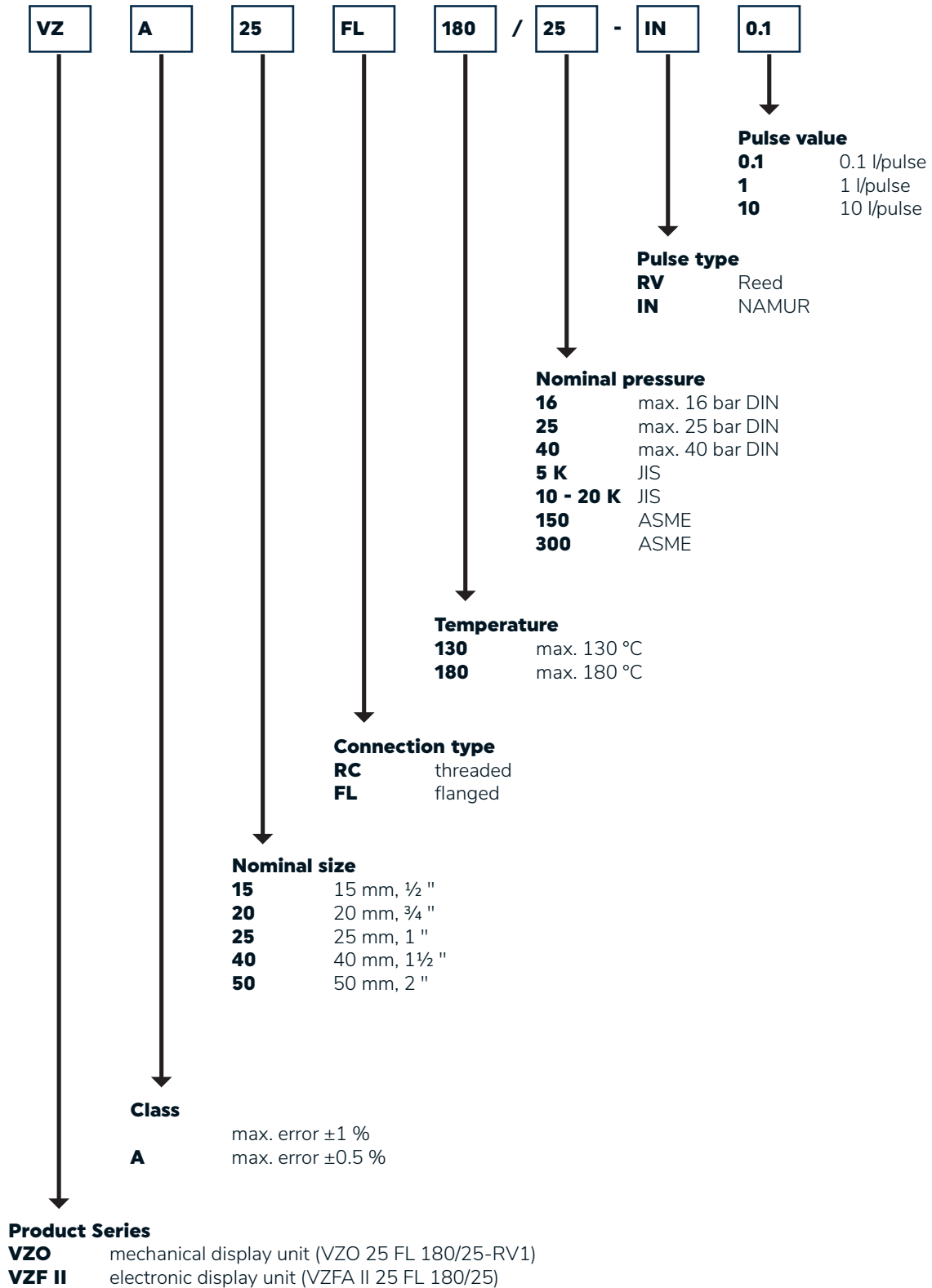



# TECHNICAL SPECIFICATIONS

## Parts

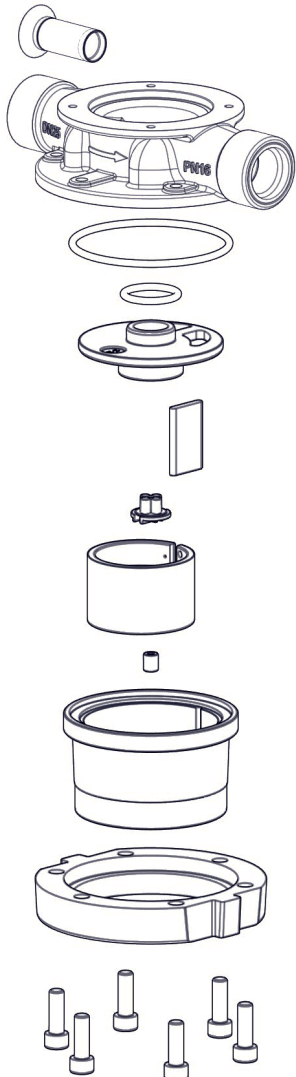
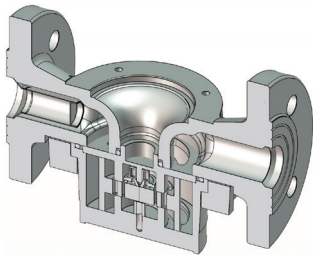

Inlet safety filter

Housing (no spare part)

Gasket big

Gasket small

Measuring chamber cover

Separating plate

Driver

Rotary piston

Guide roller

Measuring chamber

Measuring chamber flange

Screws

## Technical data CONTOIL® DN 15 - 50

### Hydraulic



Hydraulic			Meter DN size				
Nominal diameter		DN mm	15	20	25	40	50
		inch	1/2	3/4	1	1 1/2	2
Installation length		mm	165	165	190	300	350
Nominal pressure threaded ends	PN	bar	16	16	16	16	N/A
Nominal pressure flanges	PN	bar	25 / 40	25 / 40	25 / 40	25 / 40	25 / 40
Max. medium temperature	T <sub>max</sub>	°C	130 / 180				
Maximum flow rate	Q <sub>max</sub> <sup>1)</sup>	l/h	600	1500	3000	9000	30000
<b>Continuous flow rate</b>	<b>Q<sub>cont</sub><sup>2)</sup></b>	<b>l/h</b>	<b>400</b>	<b>1000</b>	<b>2000</b>	<b>6000</b>	<b>20000</b>
Minimum flow rate	Q <sub>min</sub>	l/h	20	40	75	225	750
Approx. starting flow rate		l/h	4	12	30	90	300
Max. permissible error of actual value <sup>1)</sup>	VZF II, VZO, DFM		±1.0 %	±1.0 %	±1.0 %	±1.0 %	±1.0 %
	VZFA II, VZOA		±0.5 %	±0.5 %	±0.5 %	±0.5 %	±0.5 %
	VZFA II linearized		±0.3 %	±0.3 %	±0.3 %	±0.3 %	±0.3 %
Repeatability			±0.1 %	±0.1 %	±0.1 %	±0.1 %	±0.1 %
Measuring chamber volume		cm <sup>3</sup>	12	36	100	330	1200
Safety filter mesh size		mm	0.400	0.400	0.400	0.800	0.800
Weight with threaded ends <sup>3)</sup>		kg	2.2	2.5	4.2	17.3	-
Weight with flanges PN 25		kg	3.8	4.5	7.5	20.3	41.0
Weight with flanges PN 40		kg	4.4	5.5	7.8	20.5	42.0

1) Manufacturer's specification, valid for the reference conditions as specified under reference conditions. Do not use this value for the design.

2) For burners and engines or motors, the fuel oil meter must be selected on the basis of the permanent flow rate. For higher viscosities, or if the meter is installed on the suction side, the pressure drop and any reduction in the measuring range must be taken into consideration.

3) Weight without couplings.

Hydraulic Material		Meter DN (mm) size				
Part	Material	15	20	25	40	50
Housing with threaded ends	Cast Brass	◄►	◄►	◄►		
	Spheroidal graphite iron GJS 400-15				◄►	
Housing with flanged ends	Spheroidal graphite iron GJS 400-15	◄►	◄►	◄►	◄►	◄►
Measuring chamber PN 16 / 25	Cast Brass	◄►	◄►	◄►	◄►	
	Alu-Bronze					◄►
Measuring chamber PN 40	Stainless steel	◄►	◄►	◄►	◄►	◄►
Seals	FPM fluorelastomer	◄►	◄►	◄►	◄►	◄►
Rotary piston	Anodized aluminium	◄►	◄►	◄►	◄►	◄►
Ancillaries	Plastic	◄►	◄►	◄►	◄►	◄►
Housing finish	Enameled red, RAL 3013	◄►	◄►	◄►	◄►	◄►





## Technical data CONTOIL® VZF/A II

### Electronic display



Electronic display		Meter DN size					
Nominal diameter		DN mm	15	20	25	40	50
		inch	1/2	3/4	1	1 1/2	2
Max. medium temperature	$T_{max}$	°C	130, 180				
Max. environment temperature		°C	-25 to +70				
Max. storage temperature		°C	-25 to +85				
Max. storage humidity	$rh_{max}$	% rh	95, non condensing				
Protection class			IP 66 / IP 68 / IP 69				
Total volume / mass		l, m <sup>3</sup> , G <sup>1)</sup> , kg, t, lb	max. 3 decimals (dynamic)				
Resettable volume / mass		l, m <sup>3</sup> , G <sup>1)</sup> , kg, t, lb	max. 3 decimals (dynamic)				
Flow rate			max. 3 decimals (dynamic)				
Smallest readable amount			0.001				
Maximum registration capacity			8 digits				
Registration time until overrun to zero at	$Q_{cont}$ (m <sup>3</sup> )		>100 years				
Data preservation			by non-volatile memory (EEPROM)				

1) 1 US gallon corresponds to 3.785 liters.

Outputs		
3 (2 pulse / frequency, 1 analog 4 - 20 mA)		freely selectable, totally independent of each other
Pulse output		volume or mass pulse 0 - 200 pulse/sec. (50 % duty cycle)
Current 4 - 20 mA		volume flow, mass flow or temperature signal
Frequency	$Q_{min}, Q_{max}$	volume flow, mass flow or temperature minimum, maximum and hysteresis parameterized
Limit switch	$QLim_{max}, QLim_{min}$	allows you to set an alert whenever predefined flow rates are exceeded (NC / NO)
Flow meter state switch	Alarm, Error	state and on/off parameterized (NC / NO)



<b>Electronic</b>		
Power supply	VDC	6 - 30
Quiescent current zero	mA	4
<b>Relais output</b>		
Switching element		solid state relay (out1 & out2)
Resistance ON	Ω	≤40
Resistance OFF	MΩ	≥10
Max. Supplay voltage	VDC	≤48
Max. Switching current	mA	≤50
Pulse width	ms	2 - 500 (dynamic)
Pulse frequency	Hz	0 - 200
<b>Current output</b>		
Analog output	mA	4 - 20 passive
Resolution	bit	16
Max. error	mA	±0.2
Update interval	s	<0.1 s
Maximum Load (RL)	Ω	0 to 1116, depending on external supply voltage of the power supply unit
		U-6 ———— Ω;(e.g.: 1116Ω@30V) 0.0215

**Electronic counter CONTOIL® VZF/A II**

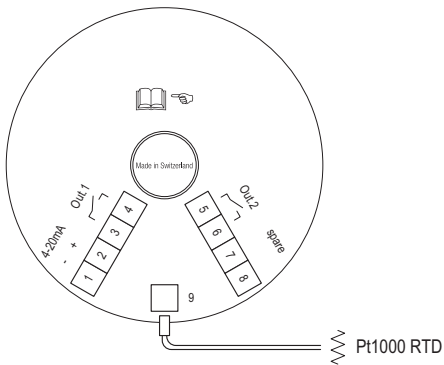

- 1 + 2 Power supply / output current loop (passive)
- 3 + 4 Output 1 (passive)
- 5 + 6 Output 2 (passive)
- 7 + 8 Spare
- 9 Temperature sensor Pt1000

Wire size for terminal 1 - 6 is:  
0.75 - 1.5 mm<sup>2</sup> / 20 - 16 AWG

**Factory setting of outputs**

- Output 1: Volume pulses: 50 ms, 1 ltr/pulse (exception: DN 15 is set to 0.1 ltr/pulse)
- Output 2: Volume pulses: 50 ms, 1 ltr/pulse (exception: DN 15 is set to 0.1 ltr/pulse)
- Analog: Disabled (off)

**Engineering notes**

The maximum frequency is calculated with the following formula:

$$\frac{\text{max. flow rate in litres/hour}}{\text{pulse value in litres} \times 3600} = \text{frequency in Hz} \leq 200 \text{ Hz}$$

## Technical data CONTOIL® VZO/A Mechanical display

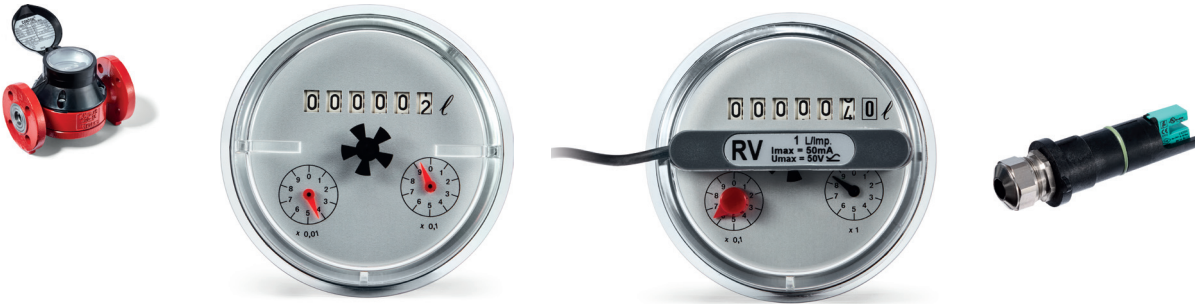

Mechanical display	Meter DN size						
Nominal diameter	DN mm	15	20	25	40	50	
	inch	1/2	3/4	1	1 1/2	2	
Smallest readable amount	l	0.01	0.1	0.1	0.1	1	
Maximum registration capacity	m <sup>3</sup>	1000	10000	10000	10000	100000	
Registration time until overrun to zero at	Q <sub>cont</sub> (m <sup>3</sup> )	h	2500	10000	5000	1667	5000

RV: Reed pulser with decadic pulse values						
Ambient temperature	°C	-10 to +70				
Switching element		Reed contact				
Switching voltage max.	VDC/VAC	48				
Switching current max.	mA	50 (Ri 47Ω / 0.5 W)				
Static current		open contact				
Switching power max.	W	2				
On-time	%	50 +/- 10 %				
RV Reed		DN 15	DN 20	DN 25	DN 40	DN 50
	l/pulse	0.1	1	1	1	10
	l/pulse	1	-	-	10	100
Pulse value		see type plate				
Protection class		IP 65				
Connection		Permanent mounted cable, 3 m long, 2 x 0.14 mm <sup>2</sup> cross section				

**No Ex zone installation possible!**

### Functional diagram reed pulser

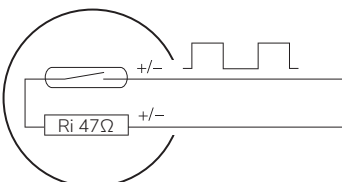



**IN: Inductive pulser with decadic pulse values**

Supply voltage	VDC	5 - 25				
Nominal voltage	VDC	8.2 (R <sub>i</sub> approx. 1 kΩ)				
Ambient temperature	°C	-10 to +70				
Protection class		IP 65				
Switching element		Slot initiator acc. to IEC 60947-5-6 (IN - NAMUR)				
Switching frequency	Hz	0 to 3000				
Residual ripple		<5 %				
Switching current	mA	≥3 (at 8.2 V, 1 kΩ)				
Static current zero	mA	≤1 (at 8.2 V, 1 kΩ)				
Pulse values for remote transmitter		DN 15	DN 20	DN 25	DN 40	DN 50
IN (NAMUR) inductive (IEC 60947-5-6)	I/pulse	0.01	0.01	0.1	0.1	1
Pulse frequency IN	Q <sub>max</sub>	16.667	41.667	8.333	25.000	8.333
	Q <sub>max</sub>	0.278	0.833	0.208	0.625	0.208
Connection		Connection cable min. 2 x 0.35 mm <sup>2</sup> and 5.5 - 13 mm external cable diameter on plug (Prefabricated cable available)				

**Pay attention to polarity when connecting the plug!**

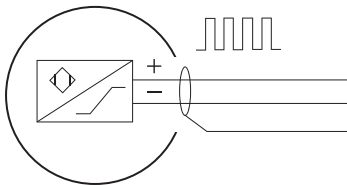
**Functional diagramm inductive sensor**

## Technical data CONTOIL® DFM blind



DFM blind unit		Meter DN size	
<b>Nominal diameter</b>	<b>DN mm</b>	<b>20</b>	<b>25</b>
	inch	3/4	1
<b>Electronic</b>			
Power supply	VDC	6 - 32	
Operating temperature	°C	-20 to +80	
Storage temperature	°C	-40 to +85	
Switching element		open drain	
Power supply	VDC	12 - 24	
Switching voltage	VDC/VAC	48	
Max. switching current	mA	50	
Pulse value		see type plate	
Pulse width	ms	20	
Protection class		IP 66	

**Functional diagramm passive output**

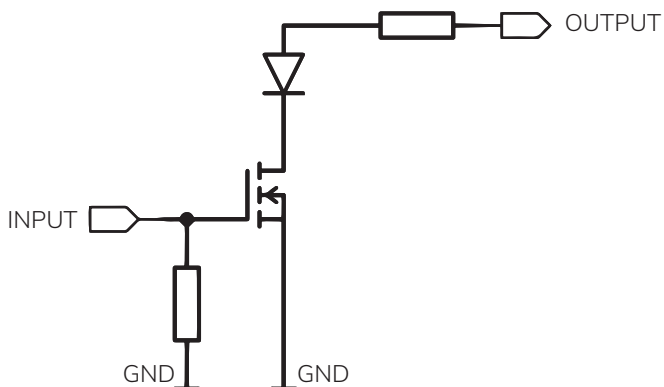

## Options for CONTOIL®

### Pairing

If the application consists of a differential measurement (supply and return), the CONTOIL® VZFA II or VZOA can be paired with higher accuracy.

The flow is measured in the supply and return line pipes. The difference between the two measurements is regarded as the consumption.

To obtain optimal measurement results, CONTOIL® VZFA II or VZOA fuel oil meters are calibrated in pairs, they are adapted precisely to the plant/system operating conditions. The flow rate occurring in each meter, the permissible pressure drop and the viscosity of the fluid must all be considered during the design phase.

The pairing range of the fuel oil meters is obtained as follows:

Flow in supply section less maximum consumption = flow in return section.

When the order is placed, the following additional information is required:

flow rate in supply section e. g. fixed pumping rate 200 l/h

flow rate in return section e. g. 120 - 190 l/h (consumption of 10 - 80 l/h)

The meters are marked "supply" and "return" during calibration and final testing in the factory. They must then be installed in the designated location. For further information on the subject of differential measurement, see the section "Project planning notes".

### Linearization

The CONTOIL® VZFA II can be linearized to achieve an even better accuracy of  $\pm 0.3\%$  across the full measuring range ( $Q_{\min}$  -  $Q_{\max}$ ). During this calibration process the flow meter is being tested across the full range with a maximum of 15 measuring points and then linearized and tested.

### Reference conditions

Measuring error limits according to technical data of meter in % of actual value for the whole measuring range.

Calibration medium: Calibration oil is similar to extra light heating oil, density at 20 °C = 814 kg/m<sup>3</sup>

Viscosity = 5.0 mm<sup>2</sup>/s according to DIN 51757 / ISO 3104 (corresponds to 4.1 mPas)

Temperature: 18 - 25 °C

Horizontal mounting, readings from counter.

CONTOIL® oil meters are never to be tested with water, otherwise they will get damaged.

### Standard measuring curve

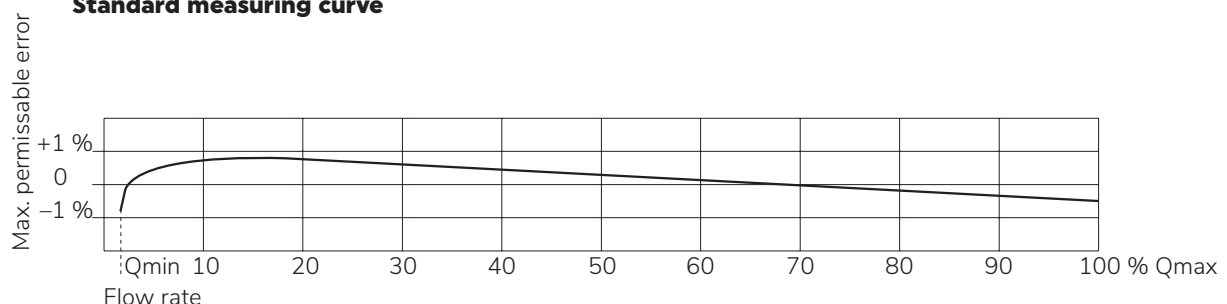

## Technical data CONTOIL® DN 15 - 50 VZFA II CE and VZOA CE



MID 2014/32/EU



Hydraulic		Meter DN size						
		Nominal diameter	DN mm	15	20	25	40	50
			inch	1/2	3/4	1	1 1/2	2
Installation length			mm	165	165	190	300	350
Nominal pressure threaded ends	PN	bar		16	16	16	16	N/A
Nominal pressure flanges	PN	bar		25	25	25	25	25
Max. medium temperature	T <sub>max</sub>	°C		130				
Max. storage humidity	rh <sub>max</sub>	% rh		95, non condensing				
<b>Maximum flow rate</b>	<b>Q<sub>max</sub></b>	<b>l/h</b>		<b>400</b>	<b>1000</b>	<b>2000</b>	<b>6000</b>	<b>20000</b>
Minimum flow rate	Q <sub>min</sub>	l/h		40	100	200	600	2000
Minimum measured volume	V <sub>min</sub>	l		2	20	20	20	200
Max. permissible error of actual value <sup>1)</sup>	VZFA II CE, VZOA CE			±0.3 %	±0.3 %	±0.3 %	±0.3 %	±0.3 %
Accuracy class				0.5	0.5	0.5	0.5	0.5
Minimal measured quantity (MMQ)	L	VZFA II CE		6	18	50	160	600
		VZOA CE		2	20	20	20	200
Measuring chamber volume		cm <sup>3</sup>		12	36	100	330	1200
Safety filter mesh size		mm		0.400	0.400	0.400	0.800	0.800
Weight with threaded ends <sup>2)</sup>		kg		2.2	2.5	4.2	17.3	-
Weight with flanges PN 25		kg		3.8	4.5	7.5	20.3	41.0

1) Manufacturer's specification, valid for the reference conditions as specified under reference conditions.

2) Weight without couplings.

The hydraulic material is described in detail on pages 12 and 13.  
Mechanical and electronic display units are available as described previously.

**Versions with type approval or calibration verification according to MI 005**

These fuel oil meters bear the test number for the metrological type test certificate in accordance with directive MID 2014/32/EU and the metrological CE mark and are therefore suitable for custody transfer. For custody transfer, the meters can only be used for direct consumption measurement and has to be installed between fixed pipes.

The measurement result can be transferred to external meters by means of pulse transmitters or pulse outputs. The transferred measurement result is not in line with the directive 2014/32/EU and cannot be used as a legally displayed result. Only the local display of the flow meter is valid for custody transfer.

**Area of use**

The CONTOIL<sup>®</sup> flow meter with MID approval is used almost exclusively where the measured liquid (heating oil, diesel) goes directly to the consumer (heating system, burner) and is offset. Other applications than the described in Project Planning Notes, must be checked and approved by the local authorities.

In accordance and compliance with the applicable norms for custody transfer, CONTOIL<sup>®</sup> fuel oil meters with MID approval can be used.

**Responsibility**

Installation, operation, maintenance and decommissioning of this device must be carried out by trained, qualified specialists, authorized by the manufacturer, operator or owner of the facility.



## Dimensional drawings

**All fuel oil meters with threaded ends are according to ISO 228-1.**

DN 15, 20, 25: with threaded ends

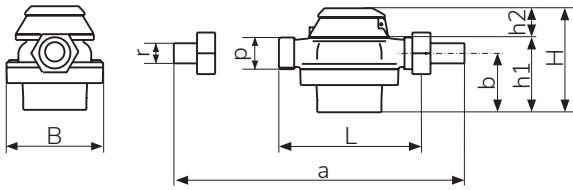

DN 40: with threaded ends

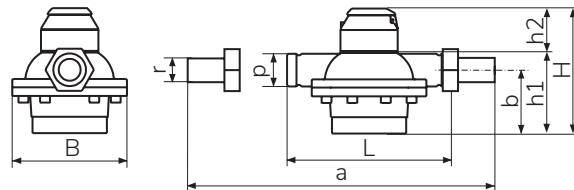

**All fuel oil meters with flanges are compatible to EN 1092-2, ASME B16.5 or JIS B2239.**

DN 15, 20, 25: with flanges

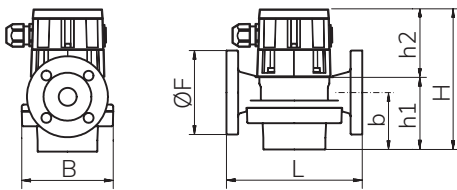

DN 40, 50: with flanges

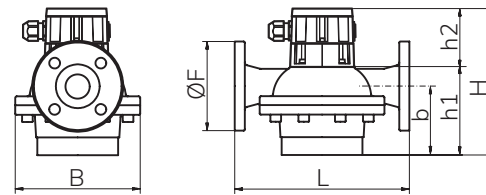

Nominal size	L	B	a*	Ø F	b	h1	p	r
DN 15	165	105	240	95	45	65	G 3/4"	G 1/2"
DN 20	165	105	260	105	54	74	G 1"	G 3/4"
DN 25	190	130	305	115	77	101	G 1 1/4"	G 1"
DN 40	300	210	435	150	116	153	G 2"	G 1 1/2"
DN 50	350	280	-	165	166	209	-	-

Dimensions in mm

a\* = without gaskets (2x ~2 mm)

h2 is explained on next page

H = h1 + h2



## Dimensions of display and pulse units

Module (h2)	VZF(A) II 15 - 50	VZO(A) 15 - 50					
Max. temperature	130/180 °C	130 °C			180 °C		
Pulsers	all	-	RV	IN	-	RV	IN
Dimensional drawing	1	2	3	6	5	4	7

1

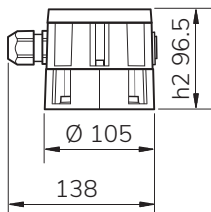

2

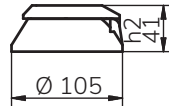

3

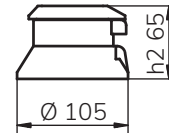

4

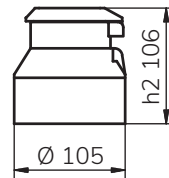

5

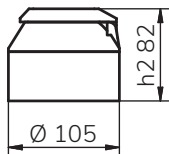

6

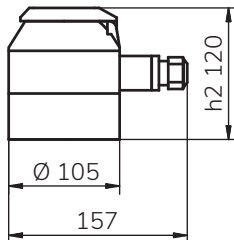

7

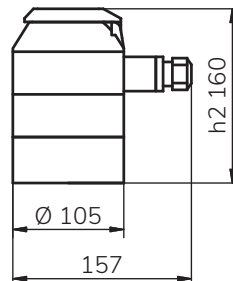

VZF II / VZFA II

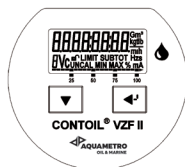

VZO / VZOA 15

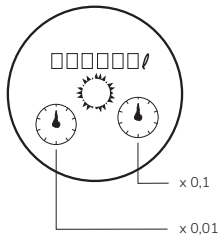

VZO / VZOA 20, 25, 40

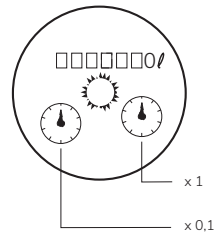

VZO / VZOA 50

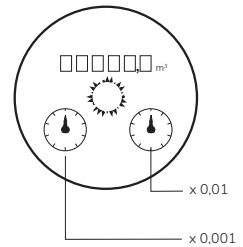

## Pressure drop curves

**DN 15**

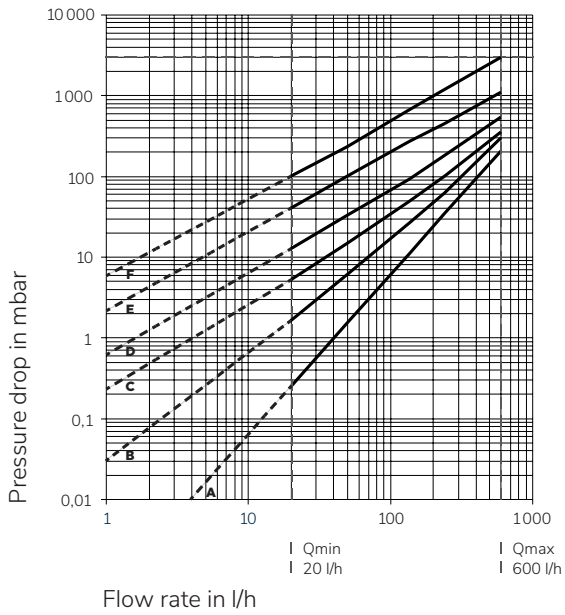

**DN 20**

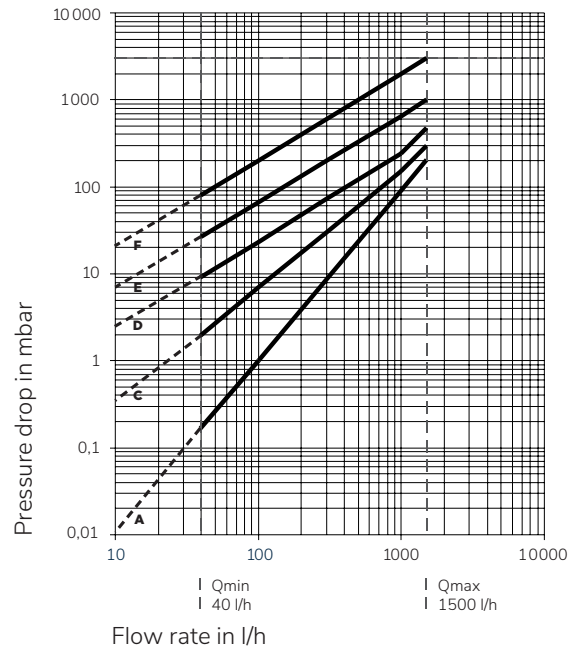

**DN 25**

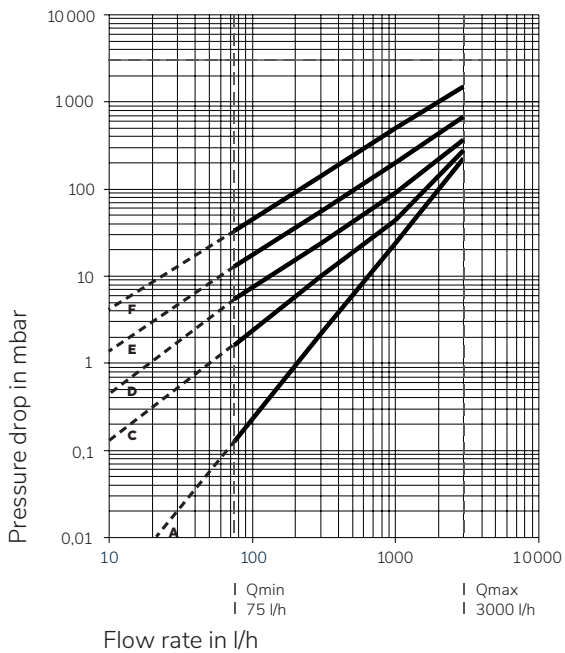

**DN 40**

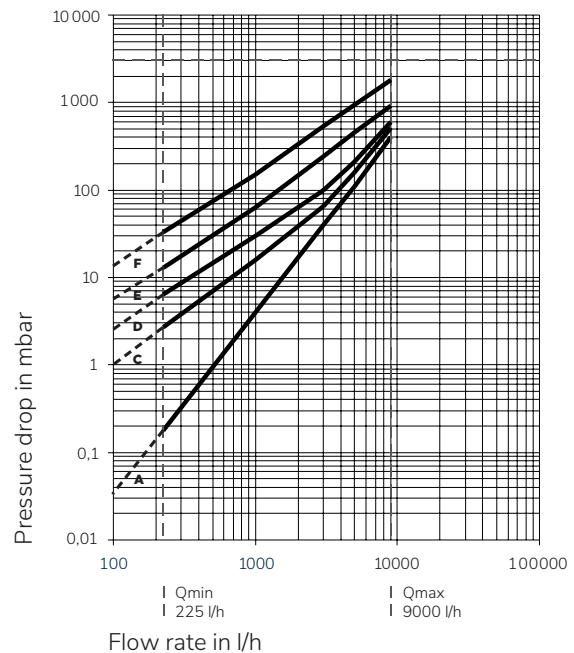





**DN 50**

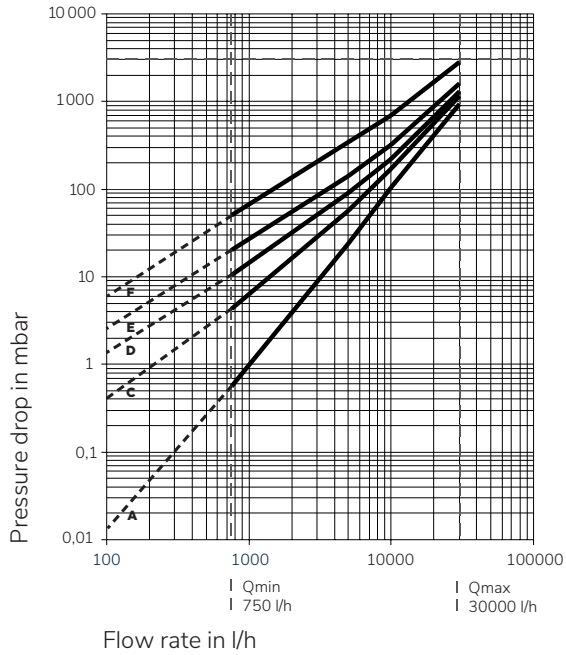

**Example**

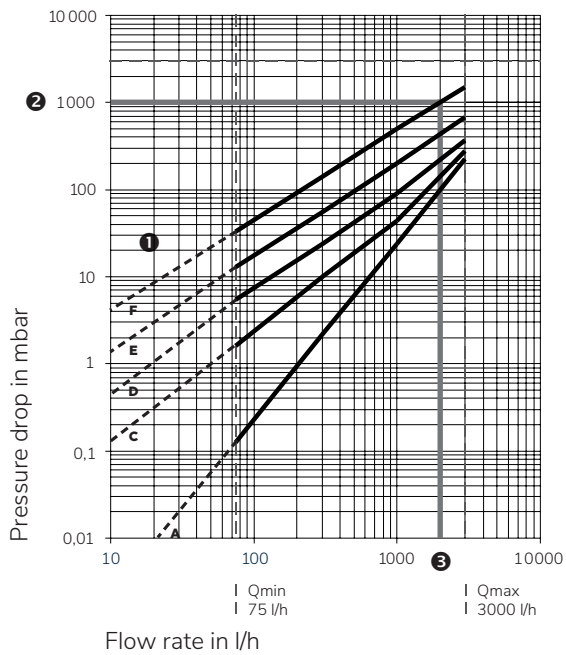

Mineral oil, viscosity 450 mPas  
 VZO 25 mounted on pressure side of pumps

- ❶ Viscosity curves DN 25  
 select closest curve  
 F = 500 mPas
- ❷ Assume max. permissible pressure drop = 1 bar
- ❸ The intersection of curve F with the line  
 corresponding to 1bar gives a flow rate of  
 2000 l/h.

**Viscosity diagrams:**

- A = 5 mPas
- B = 25 mPas
- C = 50 mPas
- D = 100 mPas
- E = 200 mPas
- F = 500 mPas

For a pressure drop of more than 1 bar, it is recommended to use the next larger meter size.

# PROJECT PLANNING NOTES

## Project Application - Burner

### Mounting on pressure side of pump

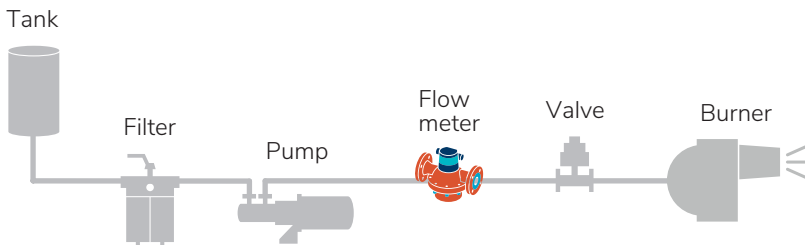

### Mounting on suction side of pump

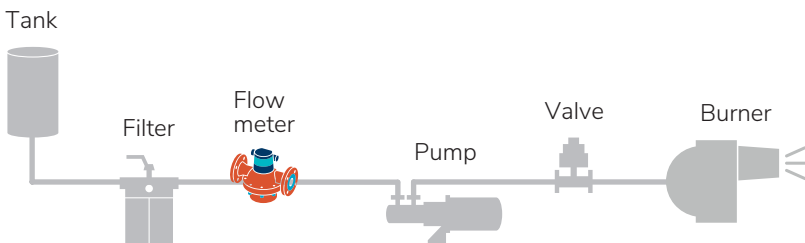

### Indicative values on power for burners

Burner		Flow meter		
Power	Flow rate heating fuel		Flow rate <i>Q<sub>min</sub> - Q<sub>cont</sub></i>	Nominal diameter
up to kW	kg/h	l/h	l/h	DN
4000	336	400	10 - 400	15
10000	840	1000	30 - 1000	20
20000	1680	2000	75 - 2000	25
60000	5040	6000	225 - 6000	40
200000	16800	20000	750 - 20000	50

Formula for consumption in litres/hour:

$$\frac{\text{Burner power in kW}}{\text{Energy value of fuel in kWh/kg} \times \text{density in kg/dm}^3}$$

Example:

$$\frac{4000 \text{ kW}}{11.8 \text{ kWh/kg} \times 0.84 \text{ kg/dm}^3} = 4000 : 9.912 = 403 \text{ l/h}$$

# Project Application - CE Approval

## Pump operation

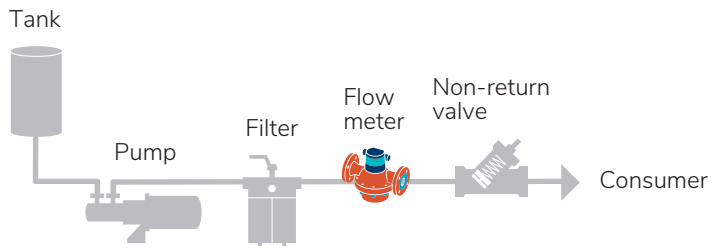

## Hydrostatic operation

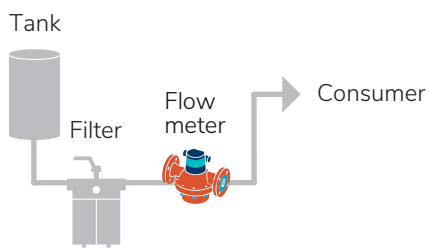

## Burner

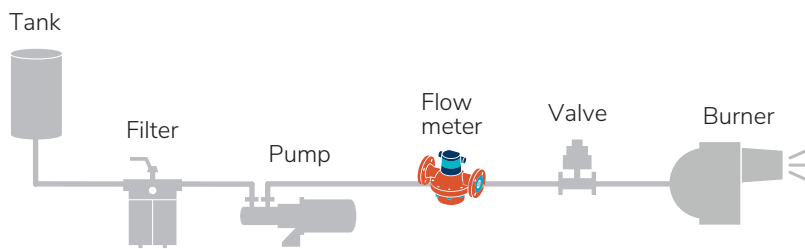

## Project Application - Engine

### Direct measurement

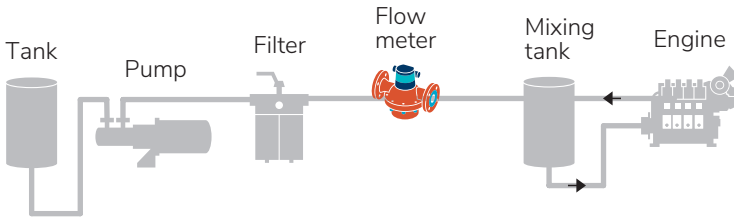

### Differential measurement

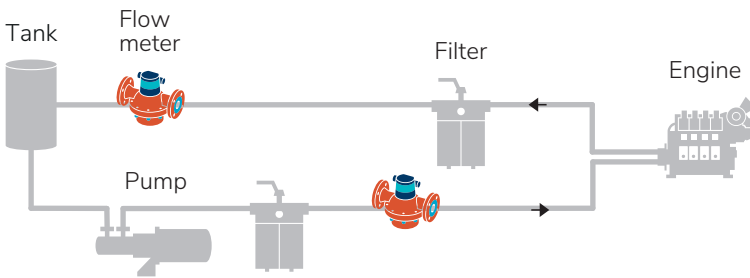

### Indicative values on power for engines

Engine		Flow meter <sup>1)</sup>		
Power	Diesel fuel consumption		Flow rate	Nominal diameter
			$Q_{min} - Q_{cont}$	
up to HP	up to kW	l/h	l/h	DN
2000	1470	400	20 - 400	15
5000	3680	1000	40 - 1000	20
10000	7360	2000	75 - 2000	25
30000	22000	6000	225 - 6000	40
100000	73600	20000	750 - 20000	50

1) For differential measurement the flow meter has to be selected according to the pump flow rate in supply and the flow in the return pipe.

Formula:  $1 \text{ DIN-HP} = 0.736 \text{ kW}$        $1 \text{ kg Diesel at } 0.84 \text{ kg/dm}^3 = 1.19 \text{ l}$   
 $1 \text{ kW} = 1.36 \text{ DIN-HP}$

Rule of thumb: approx. 190 g Diesel/kWh correspond to 0.226 l Diesel/kWh  
 approx. 140 g Diesel/HP correspond to 0.167 l Diesel/HP

## Sample calculation\* with direct and differential measurement

### Assumptions:

- » All Flow meter 1 % error
- » M/E consumption 4'000 l/hr
- » A/E SL: 3'000 l/hr RL: 2'600 l/hr
- » Circulation pump 10'000 l/hr
- » Accuracy M/E with A/E running
  - » FM2: 1 % of 3'000 l/hr » 30 l/hr
  - » FM3: 1 % of 2'600 l/hr » 26 l/hr
  - » 30 + 26 l/hr = 56 of 400 l/hr
  - » FM0: 1 % of 4'000 + 400 l/hr » 44 l/hr
  - » Total accuracy of M/E = 44 + 56 = 100 of 4'000 l/hr

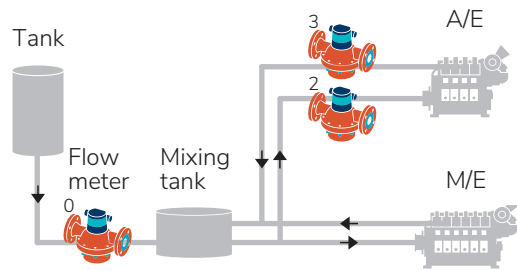

- » A/E consumption 14 % error
- » M/E consumption 2,5 % error

## Sample calculation\* with 2x differential measurement

### Assumptions:

- » All flow meter calibrated in pair: (0.1 % / 0.3 % error)
- » M/E: SL: 10'000 l/hr RL: 6'000 l/hr
- » A/E: SL: 3'000 l/hr RL: 2'600 l/hr
- » Accuracy M/E with A/E running
  - » FM2: 0.1 % of 3'000 l/hr » 3.0 l/hr
  - » FM3: 0.3 % of 2'600 l/hr » 7.8 l/hr
  - » 3.0 + 7.8 l/hr = 10.8 of 400 l/hr
  - » FM0: 0.1 % of 10'000 l/hr » 10.0 l/hr
  - » FM1: 0.3 % of 6'000 l/hr » 18.0 l/h
  - » Total accuracy of M/E = 10+18 = 28 of 4'000 l/hr

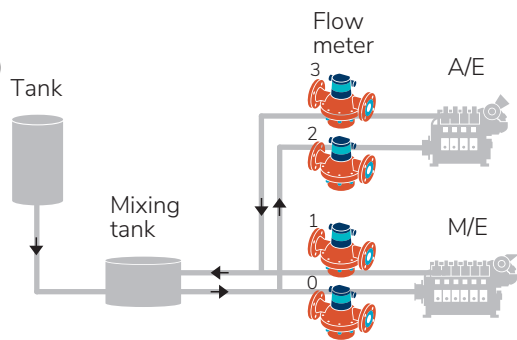

- » A/E consumption 2.7 % error
- » M/E consumption 0.7 % error

\* These are theoretical calculated values!



## Sample calculation\* for differential measurement - standard vs paired flow meters

### Assumptions:

- » Standard calibration 1 % error (CONTOIL® VZF II):
  - » Supply (FM0) 10'000 l/h  $\pm 1\% = \pm 100$  l/h
  - » Return (FM1) 10'000 l/h  $\pm 1\% = \pm 100$  l/h
  - » **Max. difference** **2 % = 200 l/h**
  
- » Pair calibration 0.1 % + 0.3 % error (CONTOIL® VZFA II):
  - » Supply (FM0) 10'000 l/h  $\pm 0.1\% = \pm 10$  l/h
  - » Return (FM1) 10'000 l/h  $\pm 0.3\% = \pm 30$  l/h
  - » **Max. difference** **0.4 % = 40 l/h**

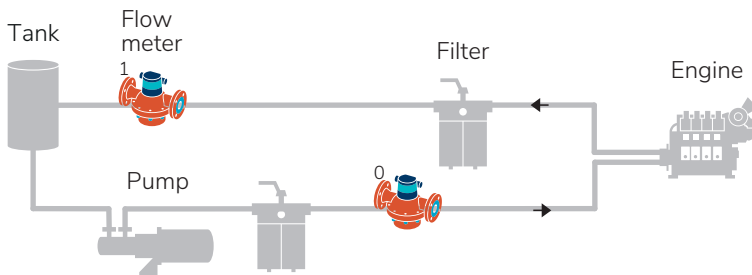

\* These are theoretical calculated values!



### Negative influencing factors

List of factors which can influence the performance of the flow meter negatively:

#### Medium

- » Seawater
- » Acid
- » Cleaning products

#### Mechanical

- » Pulsating pressure
- » Cat fines
- » Pre-filter mesh size

#### Specification

- » Dimension too big / too small
- » Over temperature

After any modification of the pipe system the system has to be cleaned / flushed **without** the flow meter installed to prevent any damage to the flow meter from any debris.

### Temperature compensation

The installation of temperature sensors at the flow meter positions is absolutely essential, without temperature compensation of the flow meter data, the error in the measurement can become extremely large, depending on the process conditions. As a rule of thumb we assume almost 1 % volume difference for each 10 °C temperature difference. (Usually there is a temperature difference between the oil in the supply line and in the return line.)

### Density compensation

If fuel oil consumption in mass needs to be compared instead of volume, it is important to know that the mass is changing with the density, which itself is changing with the temperature. To obtain most precise measurement results, it is recommended to measure the online density on board. If there is no sensor available, you have to use the density which is given in each bunkering report and calculate volume values at different temperatures back to the corresponding mass values. However there are differences in HFO quality across the world and you should consider that the density mentioned on the bunkering report refers to the required specification.

The CONTOIL® VZF II is able to calculate the mass flow with a given density, adjusted by the measured medium temperature built in the flow meter.

These calculations are done according to DIN 51757.

# INSTALLATION

## Flow meter installation

Identify the flowmeter and ensure that the flowmeter is suitable for the intended process and conditions. Easy access for reading the flow meter and controlling the ancillary equipment is important. Provided that the arrow on the housing is in the direction of flow, the flow meter can be installed in any position without any special modifications. The electronic display unit is rotatable in 90° steps to the installed position.

### Exception: upside down installation!

Flow conditioners are not required.

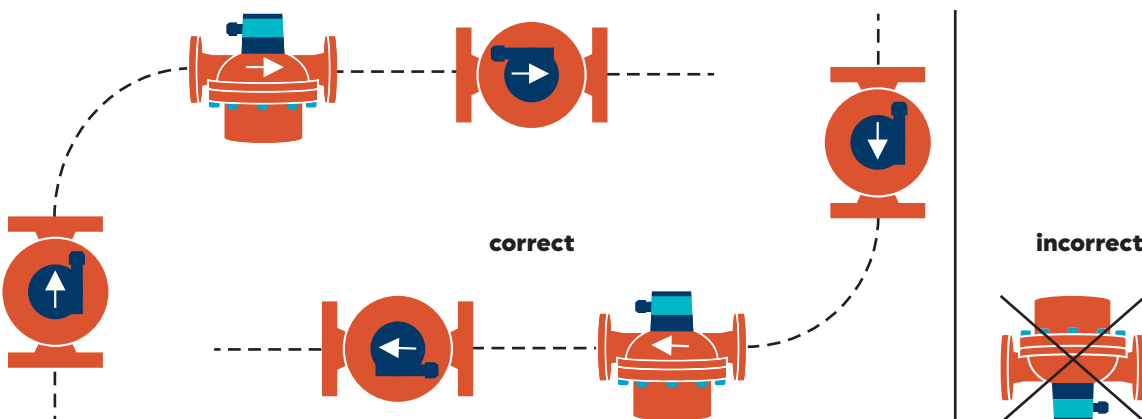

### Correct layout of flow meter and accessories

If the flow meter is used for viscosities higher than 5 mPas, or if it is mounted on the suction side of a pump, the pressure loss and the flow rate that can still be attained should be determined with the help of the pressure loss curves provided in this document. In addition, the pressure loss due to installed filters must be taken into consideration.

Select the flow meter and ancillaries according to the working conditions listed below:

- » Flow rate (max. expected application flow rate =  $\leq$  max. continuous flow rate of flow meter  $Q_{cont}$ )
- » Material compatibility with medium
- » Operating pressure
- » Operating temperature
- » Ambient temperature
- » The fuel oil meters must be selected according to the max. application flow rate (pump max.) and not according to the pipe diameter. If necessary, adapt the pipework.

**Pulsations at the flow meter shall be avoided to ensure a trouble free operation of the instrument.**



### Dirt filter, safety filter

Filters are any way required in the system to protect engines and pumps to keep their performance and life time. For fuel oil meters this is no different - that's why we recommend installing the fuel oil meters (in flow direction) always directly after the filter. Some particles in the fuel are also from engine's wear and tear, that's why we also recommend a filter in the fuel return line. Usually basket type filters are best choice for the return line and automatic filters in the supply line. Major engine producers recommend a mesh size of 5 - 10  $\mu\text{m}$  (automatic filters), especially to filter out very abrasive cat fines. It is best for the flow meter to install it between this automatic filter and the engine. The maximum filter mesh size for a respective meter can be found in below table.

Examples of filter:

#### Maximum mesh width for filters

Nominal diameter	Flow meter type	
	VZO/VZF II	VZOA/VZFA II
DN 15	0.250 mm	0.100 mm
DN 20	0.400 mm	0.100 mm
DN 25	0.400 mm	0.250 mm
DN 40	0.600 mm	0.250 mm
DN 50	0.600 mm	0.250 mm

- » The filter mounted in the meter inlet is only a safety filter and is too small to act as a dirt filter.
- » If a dirt filter with the given mesh size is used, the safety filter in the meter inlet may be removed.

### Pulsation dampers

Engines and pumps can cause pressure peaks, which are transmitted throughout the whole fuel piping system and can cause damage to all parts in the system like filters, the viscosity control system, pumps themselves as well as the fuel oil meters. It is recommended to install "pressure pulsation dampers" directly after the device, which is generating such pressure peaks (usually after the pump and after the engine).

### Pressure Loss

For the dimensioning of oil meters not only the flow rate, but also the pressure loss is important. All components in the fuel piping system and the piping layout itself cause a pressure loss. In general a higher flow and a higher viscosity cause a higher pressure loss over the flow meter. Piping bends, valves, reduction of pipes, as well as strainers and fuel oil meters do also have a pressure loss, which must be taken into account when dimensioning the fuel supply system. Please check the pressure drop at each flow meter with the help of the pressure drop curves. For a pressure drop of more than 1 bar, it is recommended to use the next larger flow meter size.

» Ideally the fuel oil meters are installed on the pressure side of the pump.

If the fuel oil meters are on the suction side of the pump there is under pressure, which can cause out-gassing of the oil (1 % gas in the oil causes 1 % measurement failure).

Depending on the viscosity of the oil it is advised to check the pressure loss and decide if there is still enough pressure after the flow meter.

### Heat insulation

The display unit shall not be insulated. This could cause its permitted temperature range to be exceeded.

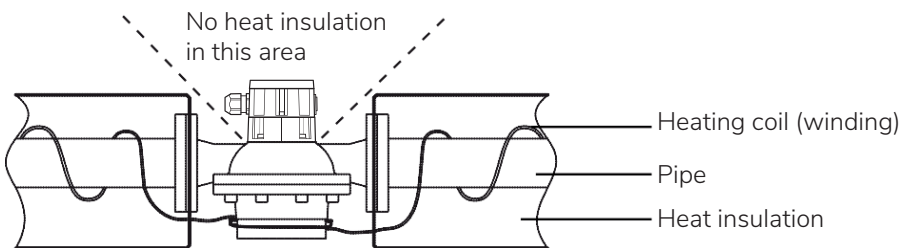

The permitted temperature ranges for the flow meter must be observed.

### Special requirements - ships

On ships, attention is required to ensure that the engine can continue to operate at full power even if there is heavy filter contamination or if the flow meter requires maintenance. A pressure switch or a manual valve can be used to switch over to the bypass and to draw attention for servicing. The engine then continues to operate without consumption measurements.

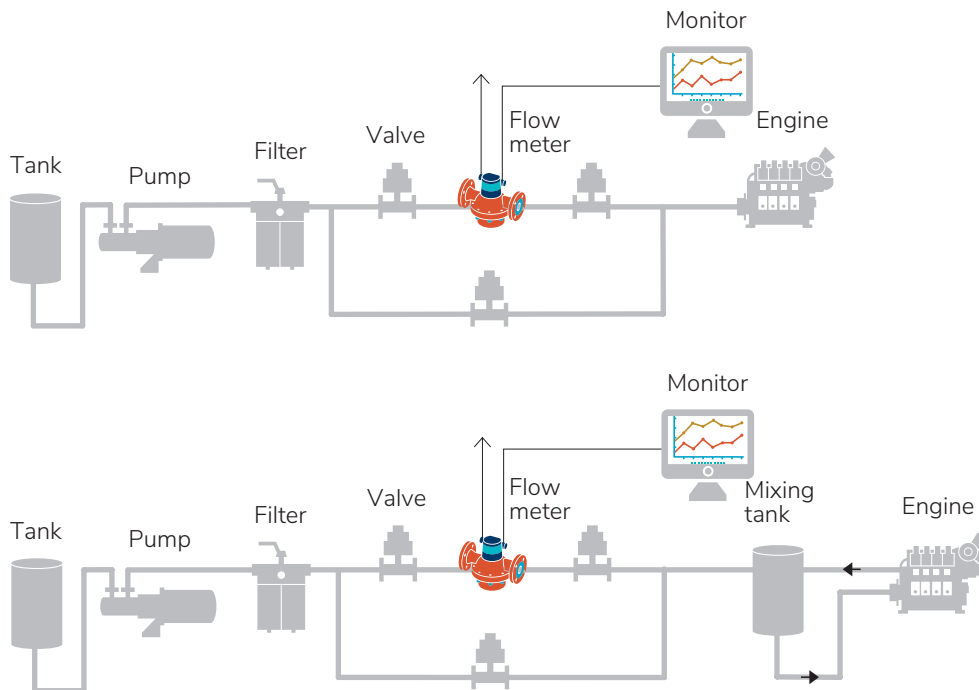

- » Ship classification societies require the installation of bypass pipes. The relevant regulations must be followed.

### Installation of the flow meter on the suction side of a pump

If the flow meter is installed on the suction side of a pump, consideration must be given to avoid air-intake or foam.

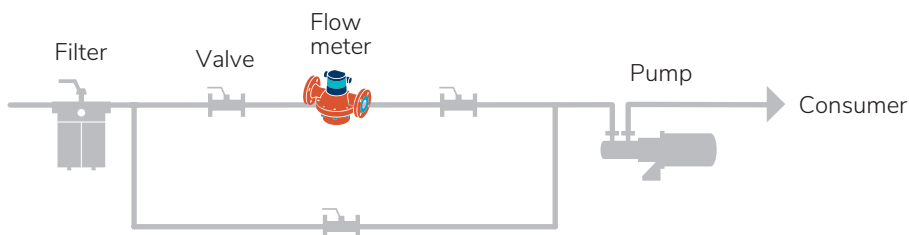

### Installation of the flow meter on the pressure side of a pump

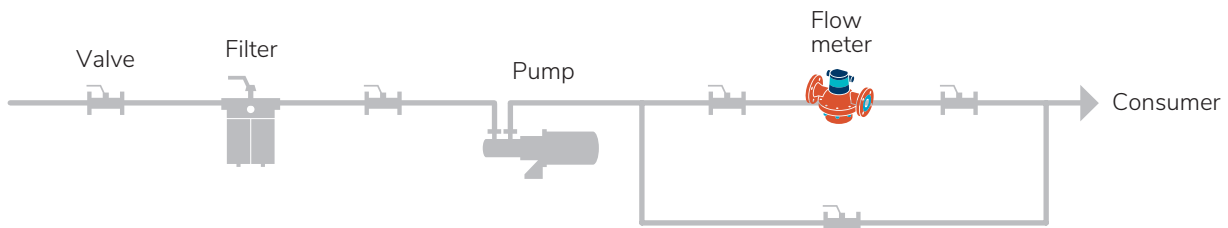

### Special requirements - filling and dosing units

For filling and dosing, the valve must be fitted between flow meter and discharge. The shorter the pipe section between valve and discharge, the higher the accuracy. Avoid water hammer if fast closing valve is installed.

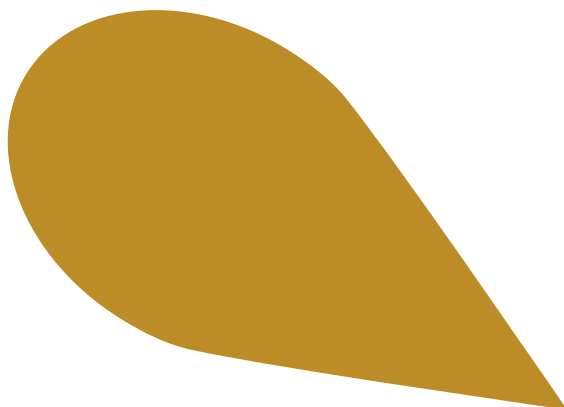
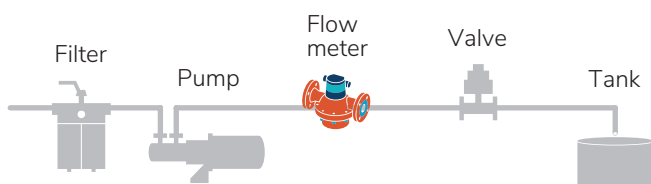

# WARRANTY, SAFETY INSTRUCTIONS

## Warranty Disclaimer

Aquametro Oil & Marine guarantees the quality of the product in the context of its General Terms of Business. The owner, operator or installer will be liable for the correct installation as well as the appropriate handling of the equipment upon its receipt.

- » Please observe the application, mounting and operating instructions.
- » Use the unit exclusively for its designed purpose.
- » Maintain the unit and service it according to prescriptions.
- » Use accessories only if their applicability is technically safe.

## Safety rules and precautionary measures

The manufacturer accepts no responsibility if the following safety rules and precautions are disregarded.

- » Modifications of the device implemented without preceding written consent from the manufacturer, will result in the immediate termination of product liability and warranty period.
- » Installation, operation, maintenance and decommissioning of this device must be carried out by trained, qualified specialists, authorized by the manufacturer, operator or owner of the facility. The specialist must have read and understood these mounting and operating instructions and must follow the instructions here in.
- » Check the voltage and the information on the type plate before installing the device.
- » Check all connections, settings and technical specifications of peripherals which may be present.
- » Open the housing or parts of housings, which electric or electronic components included, only when the electric power is turned off.
- » Do not touch any electronic components (ESD sensitivity).
- » Expose the system with respect to the mechanical load (pressure, temperature, IP protection, etc.), only to a maximum of the specified classifications.
- » During operations that involve mechanical components of the system, release the pressure in the pipe system or reduce the temperature of the medium to a safe level for humans.
- » None of the information stated here or elsewhere releases planners, installers and operators from their own careful and comprehensive assessment of the respective system configuration in terms of functional capability and operational safety.
- » The local labour and safety laws and regulations must be observed.

# CERTIFICATES

**Det Norske Veritas - German Lloyd  
Norway - Germany**



**Lloyds Register  
United Kingdom**



**RRR  
Russian River Register**



**RMRS  
Russian Maritime Register of Shipping**



**CCS  
China Classification Society**







[info@aquametro-oil-marine.com](mailto:info@aquametro-oil-marine.com)  
[www.aquametro-oil-marine.com](http://www.aquametro-oil-marine.com)

**Aquametro Oil & Marine AG**  
CH-4106 Therwil, Switzerland  
Phone +41 61 725 44 00

**Aquametro Oil & Marine GmbH**  
DE-18119 Rostock, Germany  
Phone +49 381 382 530 00

VD 4-300 e 04.2020  
The english version shall prevail. Subject to change without notice.  
All intellectual property rights are exclusively with Aquametro Oil & Marine AG, Switzerland